

2024 HOMER NEW LIST PRODUCTS

NEW



TORPEDO-CLEAT casted AISI 316
Cleat in streamlined design, delivery including 2 fixing bolts

ITEM NO.	L mm	L1 mm	Bolt mm	Weight/g
B23-048	100	30	6	

NEW



NO SOUND PULL OUT CLEATS casted AISI 316

ITEM NO.	Length mm	Thread	Weight/g
B23-036	155(6-1/8")	M10	540

NEW



POP-UP MINI CLEATS casted AISI 316
for small boats.

ITEM NO.	Base mm	Hole mm	Weight/g
003871	89x31	22	260
003874	130x39	34	410

NEW



DOOR CLAMPS casted AISI 316

Two versions

ITEM NO. **B23-050**



DECK FILL WITH KEY casted AISI 316

ITEM NO.	O.D. mm	Dia mm	Marking	Weight/g
008893	90	50(2")	GAS	690
008894	90	50(2")	DIESEL	690
008895	90	50(2")	FUEL	690



FRONT HATCH FITTING casted AISI 316

In heavy design bolt diameter:8mm

ITEM NO.	Length	weight/g
B23-051	60mm	
B23-052	105mm	



DECK FILL WITH KEY casted AISI 316

ITEM NO.	O.D. mm	Dia mm	Marking	Weight/g
B23-037	75(3")	38(1-1/2")	GAS	
B23-038	75(3")	38(1-1/2")	DIESEL	
B23-039	75(3")	38(1-1/2")	FUEL	



NEW

SINGLE LEAD BLOCK AISI 304

For rope Φ 6mm
plastic sheaves 30x11mm

ITEM NO.	Weight/g
B23-049	31

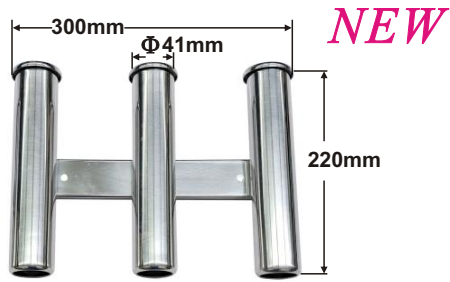

ROD HOLDER FOR 3 FISHING ROD

Made of stainless steel tube AISI 304

ITEM NO.	Length
B23-053	300mm



ROD HOLDER FOR 4 FISHING ROD

Made of stainless steel tube AISI 304

ITEM NO.	Length
B23-054	420mm



SWIVELING TRIPLE COAT HOOK AISI 316

ITEM NO.	D mm	D1 mm	H mm	W mm	Weight/g
B23-025	50	65	57	25	100



HANDLE AISI 316

ITEM NO.	L mm	L1 mm	IH mm	H mm	Weight/g
B23-026	141	170	32	40	230



FLUSH LIFTING HANDLE precision casted AISI 316

ITEM NO.	LxW	Handle	Thickness	Weight/g
B23-031	75x59mm	58x33mm	2.5mm	180
	(3"x2-5/16")	(2-5/16"x1-5/8")		

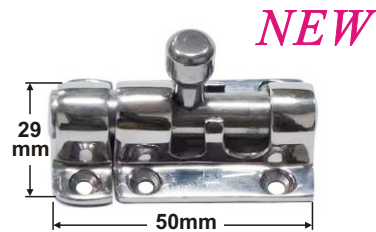

STAINLESS BARREL BOLTS

precision casted AISI 316

ITEM NO.	Overall
B23-029	50mmx29mm

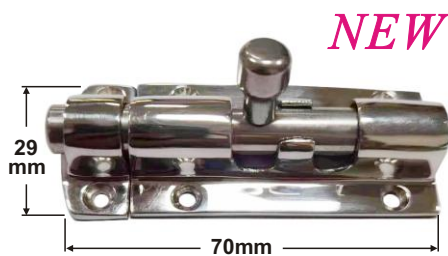

STAINLESS BARREL BOLTS

precision casted AISI 316

ITEM NO.	Overall
B23-030	70mmx29mm

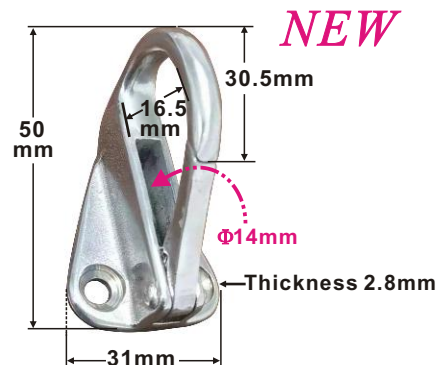

FENDER HOOK WITH SAFTY SNAP AISI 316

ITEM NO. **B23-009**



SAFE SNAP AISI 316
Stainless steel,
It is good for sail boat
ITEM NO. **2431-SS**



INSPECTION PORT ADJUSTABLE KEY AISI 304
Stainless steel
Flexible wire you can use one key for
all kind of inspection ports which is the advantage.
ITEM NO. **B22-001**



**HANDRAIL END FITTING/
EMBOUT MAIN COURANTE**
casted AISI 316
ITEM NO. Φ mm L mm Weight/g
B23-004 25 65 160



**HANDRAIL CENTER FITTING/
PASSAGE MAIN COURANTE**
casted AISI 316
ITEM NO. Φ mm L mm Weight/g
B23-005 25 65 90



TOP SLIDE WITH NUT casted AISI 316
Ideal for installing bimini tops stringers
for fender racks or wherever a rail
mounted hinge is commonly needed
ITEM NO. Tube O.D.
B23-002 22mm(7/8")
B23-003 25mm(1")



**SNEATCH CLEAT/
SNATCH PLATE** AISI 316
ITEM NO. **B23-006**



RAIL MOUNT FLAG POLE SOCKET
casted AISI 316
ITEM NO. for tube- Φ L L1
B22-004 25mm 20mm 40mm



SPINNAKER POLE HOLDER AISI 304
for Φ 25mm tube Ring Φ 65mm
ITEM NO. Weight/g
B23-035 86

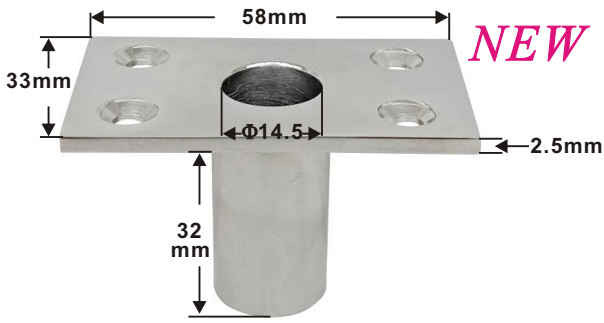

NEW

FLUSH MOUNT POLE SOCKETS AISI 316

Vertical sockets are typically used on the bow

ITEM NO.	I.D.	Weight/g
B23-007	14.5mm	55



NEW

NEW ANTENNA RATCHET MOUNTS casted AISI 316
Thread 1"-14
ITEM NO. **B22-019**



NEW

STAINLESS STEEL EXTENSIONS

For metal GPS bases.

ITEM NO.	Tube Φ	Threaded	H mm	Weight/g
B23-008	32mm	1"	100	208

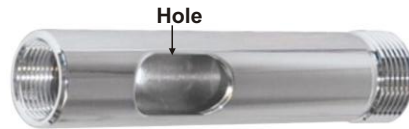

NEW

STAINLESS STEEL EXTENSIONS WITH HOLE

For metal GPS bases.

ITEM NO.	Tube Φ	Threaded	H mm	Weight/g
B23-055	32mm	1"	100	208



NEW

—stainless steel

FASTENING SET FOR SUPS

With the attachment kit you can easily attach your SUP to the board ! 360 adjustable clamps made of high-strength nylon material with high degree of flexibility.

Suitable for pipes dia. 22 to 30mm

Snap closure length: 180cm

ITEM NO. **B23-032**

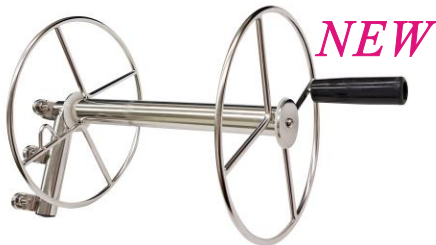

NEW

REEL FOR SAFETY LINE AISI 304

with approx 100 meters cord dia 10mm for recure-body vertical mount

Roll over all 200mm

Width 450mm

ITEM NO. Weight/g

B23-027 1800

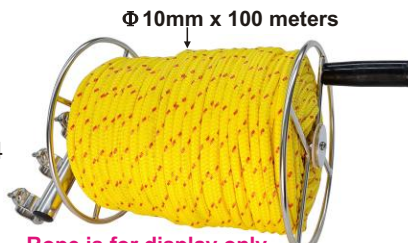

Rope is for display only
The product is not including rope



NEW

BUTTERFLY VENT stamped AISI 304
 ITEM NO. Φ mm
B23-041 180



NEW

VENT WITH THREAD casted AISI 316
 Heavy duty
 ITEM NO. Lmm x Wmm Thread Weight/g
B23-034 127(5-1/16")x127(5-1/16") M6 400



NEW

LIVE BAIT WATERSCOOP T/S PUMP
 stainless steel
 ITEM NO. **B23-013**



NEW

LIVE BAIT WATERSCOOP
 stainless steel
 ITEM NO. **B23-014**



NEW

BERLEY CHOPPER
 stainless steel
 ITEM NO. **B23-012**



NEW

CLOTH HANGER
 stainless steel tube
 ITEM NO. **B23-045**



NEW

FENDER STRIP AISI 316
To mount on support PVC UV bases
ITEM NO. **B23-010**

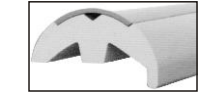

PVC UV resistant bases

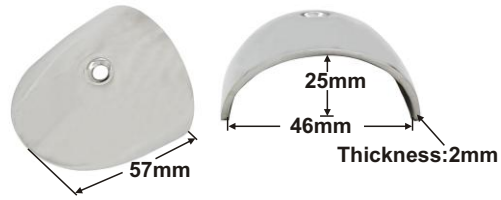

NEW

FENDER STRIP AISI 316
To mount on support PVC UV bases
ITEM NO. **B23-011**

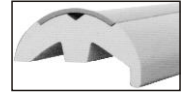

PVC UV resistant bases



NEW

FENDER STRIP AISI 316
To mount on support PVC UV bases
ITEM NO. **B23-020**

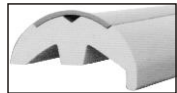

PVC UV resistant bases



NEW

FENDER STRIP AISI 316
To mount on support PVC UV bases
ITEM NO. **B23-021**

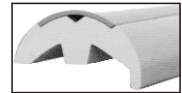

PVC UV resistant bases



NEW

FENDER STRIP AISI 316
To mount on support PVC UV bases
ITEM NO. **B23-022**



PVC UV resistant bases

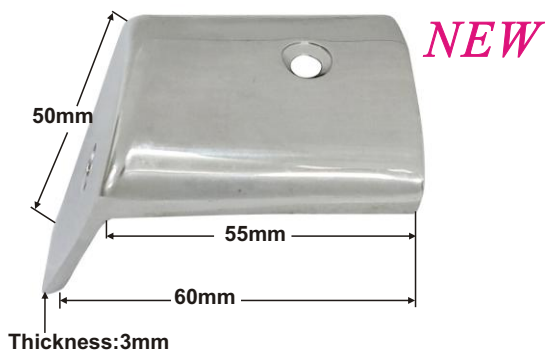

NEW

FENDER STRIP AISI 316
To mount on support PVC UV bases
ITEM NO. **B23-024**



PVC UV resistant bases



NEW

FENDER STRIP AISI 316
To mount on support PVC UV bases
ITEM NO. **B23-023**



PVC UV resistant bases

2023 NEW PRODUCTS



FENDER HALTER MIT DREHVERSCHLUSS AISI 316

Swivel fender holder

ITEM NO.	L mm	L1 mm	H mm	W mm	weight/g
B22-005	63	18	27	25	120

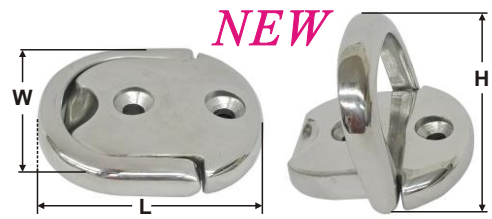

FOLDABLE PAD EYE AISI 316

ITEM NO.	L mm	H mm	W mm	weight/g
B22-006	70	55	60	150

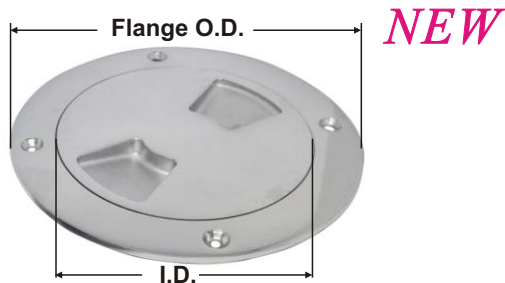

INSPECTION PORT casted AISI 316

ITEM NO.	I.D. mm	Flange O.Dmm	Cut out Hole size mm	Weight/g
B22-007	75(3")	119(4-11/16")	85(3-3/8")	479
B22-008	100(4")	141(5-9/16")	111(4-3/8")	753



DOOR STOP AND CATCHER

casted AISI 316

ITEM NO.	Weight/g
B22-009	202



LIFTING HANDLE AISI 316

ITEM NO.	D mm	D1 mm	A mm	B mm	weight/g
B22-010	61	51	21	39	280

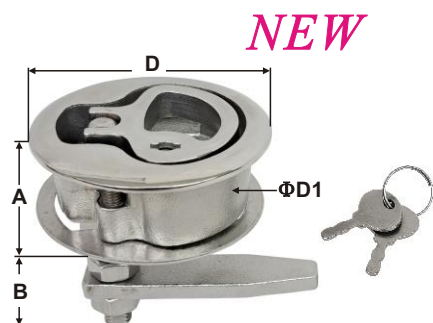

LIFTING HANDLE WITH KEY AISI 316

ITEM NO.	D mm	D1 mm	A mm	B mm	weight/g
B22-011	61	51	21	39	280



NEW

INSPECTION PORT ADJUSTABLE KEY AISI 304
 Stainless steel
 Flexible wire you can use one key for all kind of inspection ports which is the advantage.
 ITEM NO. **B22-001**

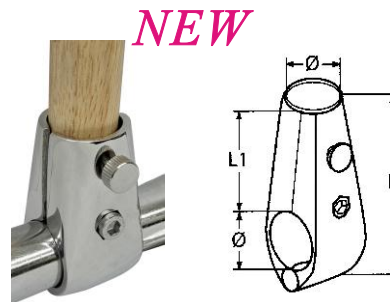

NEW

RAIL MOUNT FLAG POLE SOCKET
 casted AISI 316
 ITEM NO. for tube- Φ L L1
B22-004 25mm 20mm 40mm

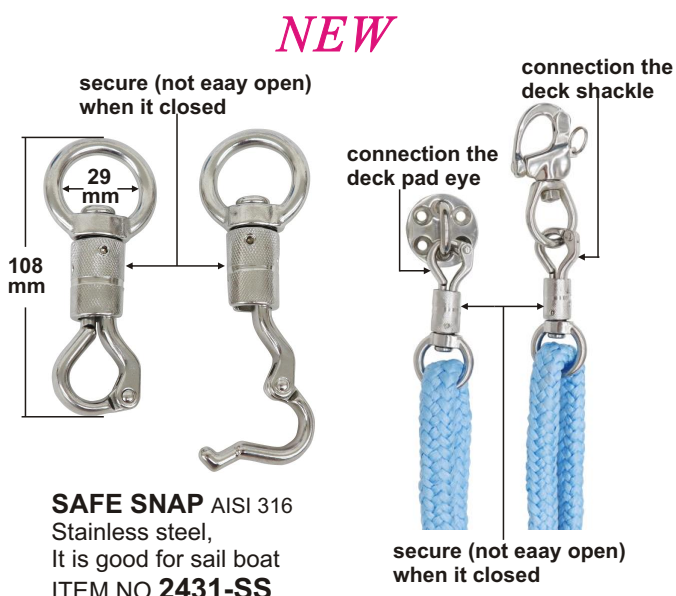

NEW

SAFE SNAP AISI 316
 Stainless steel,
 It is good for sail boat
 ITEM NO. **2431-SS**

2021 NEW PRODUCTS

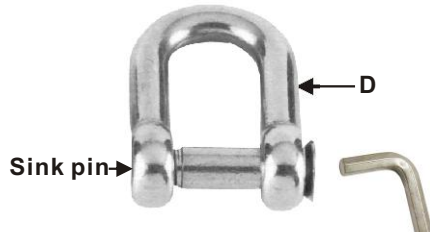

D SHACKLE WITH OVAL SINK PIN AISI 316

ITEM NO.	D mm	BL/KG	Weight/g
003406	6(1/4")	1800	22
003408	8(1/3")	3500	45
003410	10(2/5")	5400	100

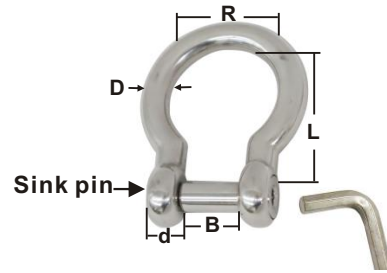

BOW SHACKLES WITH OVAL SINK PIN AISI 316

ITEM NO.	D	B	R	d	L	BL/KG	Weight/g
	mm	mm	mm	mm	mm		
001306-P	6(1/4")	12	21	12	24	1500	29
001308-P	8(5/16")	16	28	16	32	2300	73
001310-P	10(13/32")	20	34	20	40	3700	136

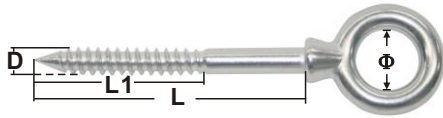

SCREW EYES AISI 316
Eye with screw thread is ideal for balustrade ends into wooden poles and for other applications

ITEM NO.	D	L mm	L1 mm	phi mm
001800	5	50	30	11
001801	6	60	35	14
001802	8	80	50	18
001803	10	100	60	22



WOOD SCREW EYE RING AISI 316

ITEM NO.	D	D1	L mm	L1 mm	phi mm
001816	5	6	50	30	35
001817	6	6	60	35	35
001818	8	8	80	50	45
001819	10	8	100	60	50



SAFETY JAW AND JAW SWIVEL AISI 316

ITEM NO.	Size	L	B	C	D	BL/KG	Weight/g
		mm	mm	mm	mm		
000317	6	66	12	11	6	1350	61
000318	8	94	16	16	8	2500	160
000319	10	118	20	22	10	3500	320

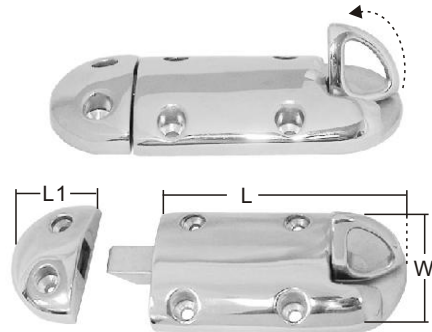

LOCKING DEVICE WITH SPRING LOADED BOLT casted AISI 316

ITEM NO.	L mm	L1 mm	W mm	Weight/g
008399	100	35	52	282

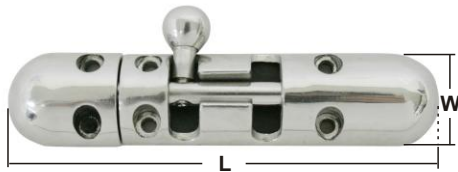

SLIM BARREL BOLT casted AISI 316
Visible mounting holes integral friction pad eliminates rattle and provides smooth operation.

ITEM NO.	Lmm	Wmm	Weight/g
008319	88	18	60

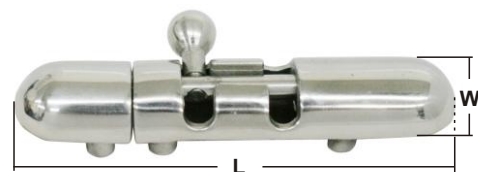

SLIM BARREL BOLT casted AISI 316
Visible mounting holes integral friction pad eliminates rattle and provides smooth operation.

ITEM NO.	Lmm	Wmm	Weight/g
008311	88	18	60



HOMER MFG & CO., LTD.
P.O. BOX 22-23, TAICHUNG, TAIWAN

360, SEC.1 SHIN LIN RD. TA YA HSIANG TAICHUNG HSIEN TAIWAN
TEL:886-4-25661433.25661494.25673955 FAX:886-4-25672783
E-mail:info@homer-bh.com.tw
Website:http://www.homer-bh.com.tw



90° BARREL BOLTS precision casted AISI 316
 ITEM NO. Overall mm Weight
008340 55x39(2-3/16"x1-1/2") 100g



ECCENTRIC LATCH WITH PADLOCK EYE stamped AISI 304
 ITEM NO. Total length Width Travel Weight/g
008348 82mm 20mm 4.5mm 60

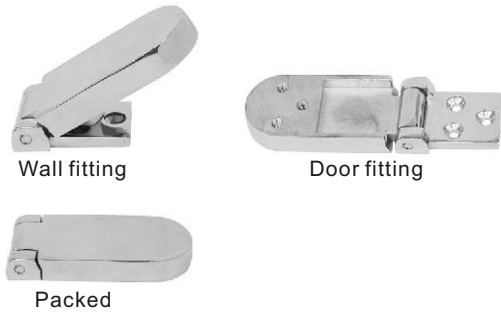

HEAVY DUTY HINGE casted AISI 316
 Packed Wall fitting Door fitting
 ITEM NO. mm mm mm Weight/g
008614 45x30 25x30 20x30 92



COVERS WITH HINGES AISI 304
 No visible screw, easy to clean
 ITEM NO. **006137**



COVERS WITH HINGES AISI 304
 No visible screw, easy to clean
 ITEM NO. **006138**



COVERS WITH HINGES AISI 304
 No visible screw, easy to clean
 ITEM NO. **006139**



DOOR HINGE precision casted AISI 316
 Reverse
 ITEM NO. WxLmm Thickness Weight/g
008512 38x75(1-1/2"x3") 4.5mm 89

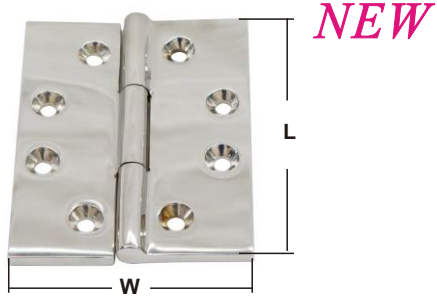

DOOR HINGE precision casted AISI 316
 ITEM NO. WxLmm Thickness Weight/g
008515 80x100(3-3/16"x4") 4mm 300

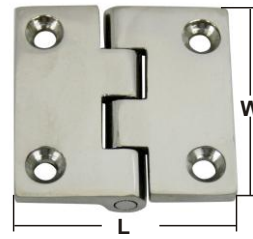

DOOR HINGE precision casted AISI 316
 Reverse
 ITEM NO. WxLmm Thickness Weight/g
008511 50x50(2"x2") 4.5mm 89



HINGE casted AISI 316
 ITEM NO. L mm B mm Thickness Weight/g
B19-027 85 18 4.5mm 120

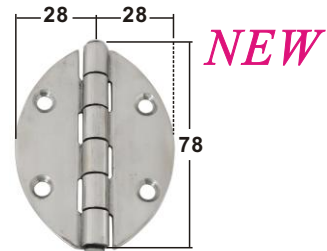

HINGE stamped AISI 304
 ITEM NO. Thickness Weight/g
B19-028 2mm 70



LIFT OFF HINGE stamped AISI 304
 ITEM NO. Thickness Weight
008516 2.0mm 40g

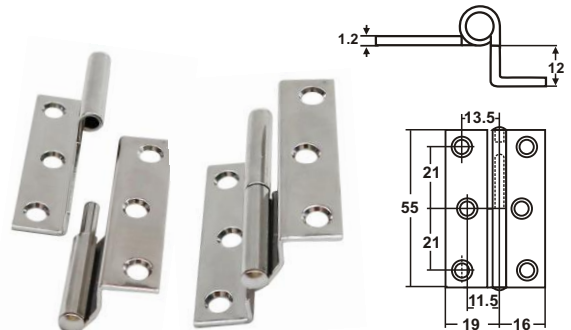

LIFT OFF HINGE stamped AISI 304
 ITEM NO. Note Weight/g
B18-015L Right handed 36
B18-015R Left handed 36

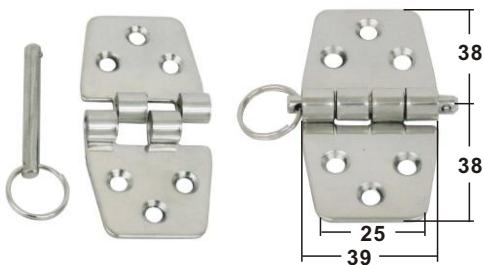

HINGE WITH PIN stamped AISI 304
 ITEM NO. Thickness Weight/g
008514 2mm 50

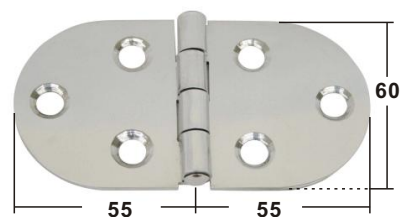

HINGE stamped AISI 304
 ITEM NO. Thickness Weight/g
008513 2mm 95

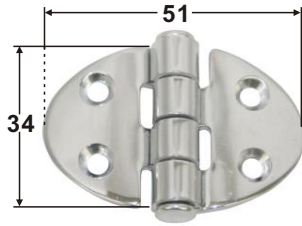

HINGE Stamped AISI 316
Buff polished
ITEM NO. Thickness Weight
006134 2mm 30g

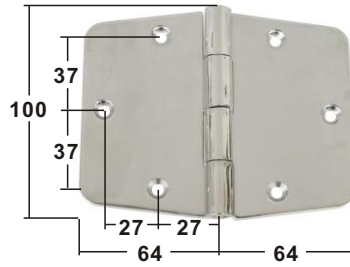

HINGE stamped AISI 316 buff polished
ITEM NO. Thickness Weight/g
006132 3mm 340



BOAT HOOK HOLDER WITH LONG HOOK AISI 304
ITEM NO. L mm L1 mm W mm Thickness
B19-030 105 65 15 4mm

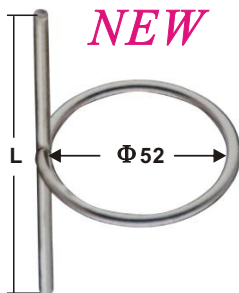

BOAT HOOK HOLDER AISI 304
Simple fixing e. g. with tap, clamp
ITEM NO. L mm L1 mm Φ mm
B19-041 102 60 52

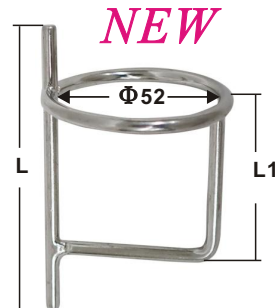

BOAT HOOK HOLDER AISI 304
Simple fixing e. g. with tap, clamp
ITEM NO. L mm L1 mm Φ mm
B19-042 102 60 52

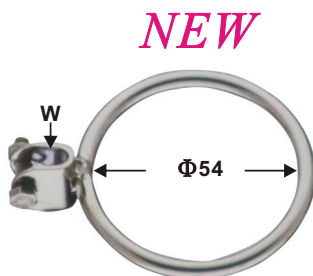

BOLDING RING FOR BOAT HOOK AISI 304
ITEM NO. Φ mm W mm
B19-043 54 up to 7mm wire

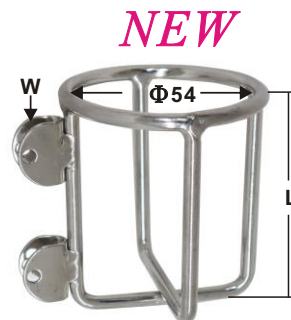

BOAT HOOK HOLDER AISI 304
ITEM NO. L mm Φ mm W mm
B19-044 79 54 up to 7mm wire



EYE PLATE with WASHER & NUT
stamped AISI 304

ITEM NO.	Φ mm	Thickness	d mm	Weight/g
003590	33	2.5mm	M6	28
003591	40	2.5mm	M8	50
003592	50	3.0mm	M10	90

NEW



**ROUND EYE PLATE WITH
THREAD AND RING** AISI 304

ITEM NO.	Φ mm	Thickness	d mm	Ring	Weight/g
B19-024	33	2.5mm	M6	5x30	40
B19-025	40	2.5mm	M8	6x35	70
B19-026	50	3.0mm	M10	8x45	140



NEW

ROUND RING WITH PLATE stamped AISI 304

ITEM NO.	L mm	B mm	Ring mm	Weight/g
B19-039	70	40	Φ 10x80	290

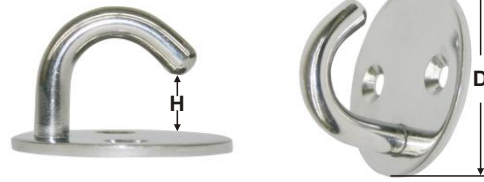

ROUND PLATE HOOKS stamped AISI 304

ITEM NO.	D mm	H mm	Thickness	Weight/g
003695	33	9	2.5mm	20
003696	40	9	2.5mm	40
003697	50	15	3.0mm	60



PLATE HOOK stamped AISI 304

ITEM NO.	L mm	W mm	H mm	Weight/g
003597	45(1-49/64")	15(5/8")	9	15
003598	60(2-23/64")	20(25/32")	13	30
003599	80(3-5/32")	25(1")	15	60



EYE PLATE WITH FIXED RING
stamped AISI 304

ITEM NO.	L mm	B mm	Ring mm
B18-013	70	40	Φ8x45



HEAVY DUTY ROUND PAD EYES AISI 316

ITEM NO.	Base	Inside	Ring	
	Dia	Dia	Dia	
003693	58mm	17mm	9.5mm	6000kg(13200Lb)
	(2-1/4")	(11/16")	(3/8")	



DOUBLE FOLDING PAD EYE AISI 316

ITEM NO.	Fold down when not in use double ring		Weight/g
	Ring	Breaking load	
003692	10mm	9000 kg	



DECK PLATE WITH SWIVEL SNAP

SHACKLE AISI 316

ITEM NO.	A mm	L mm	W mm	Weight/g
003684	16	75	28	110
003688	21	95	35	270



3 BAR MOVEABLE HOOKS casted AISI 316

ITEM NO.	L mm	W mm	Weight/g
003129	69(2-3/4")	38(1-1/2")	170

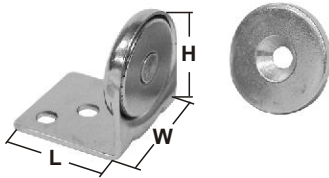

MAGNETIC CLASPS stamped AISI 304

For 3/4"(19mm) thick surfaces.

ITEM NO.	Dimensions	Capacity	Weight/g
003687	31mmL x 28mmW x 31mmH 1-1/4"(L) x 1-1/8"(W) x 1-1/4"(H)	18kg (40lb)	



Flush strike

MAGNETIC DOOR & WINDOW HOLDER

Casted AISI 316

ITEM NO.	Weight/g
003698	220



DOOR STOP AND CATCHER 90°

casted AISI 316

ITEM NO.	L mm	H mm	Φ mm	Weight/g
B19-017	92	52	50	180



CABIN HOOK casted AISI 316

ITEM NO.	L mm	W mm	Weight/g
B19-021	96	37	90
B19-022	65	37	



DOOR LOCK HOOK casted AISI 316

with double swivel

ITEM NO.	L mm	Weight/g
B19-033	70(2-3/4")	64
B19-045	90(3-9/16")	71
B19-046	120(4-3/4")	77

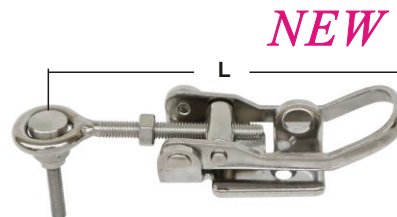

ECCENTRIC LATCH stamped AISI 304

ITEM NO.	adjustable L mm	Weight/g
B19-035	109 ~ 114	110



OVAL GRAB RAILS AISI 304

ITEM NO.	Length	Weight/g
002271	9"(23cm)	134
002272	12"(30cm)	179
002273	18"(46cm)	234
002274	24"(61cm)	329

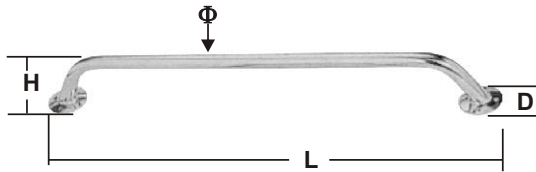

HANDLE AISI 304

ITEM NO.	L mm	H mm	D mm	Φmm
002240	400	75	51	20
002260	600	75	51	20

on request AISI 316



HANDLE high polish AISI 316

ITEM NO.	L mm	H mm	Weight/g
002228	250	30	
002229	300	30	
002230	400	30	400
002231	500	30	
002232	600	30	
002233	700	30	

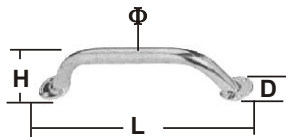

HANDLE AISI 304

ITEM NO.	L mm	H mm	D mm	Φmm
002227	270	65	40	20



HANDLE high polish AISI 304

Include mounting plate, screw

ITEM NO.	L mm	H mm
002219	300	40
002220	450	40



HANDRAIL AISI 304

ITEM NO.	L mm	H mm	Weight
002225	300(12")	42	420g
002226	400(18")	42	514g



HANDLE AISI 316

ITEM NO.	L mm	H mm	Weight
B16-006	250	135	480g



PULL HANDLES AISI 304
solid stainless steel rod, satin finished, pull features a stylish look and easy grip design features ample hand clearance. Ideal for cabinets and drawers of all varieties. (Less screw)

ITEM NO.	L mm	Rod Dia mm	Thread	Weight/g
002202	76 (3")	10	M4	55
002203	90 (3-1/2")	10	M4	81
002204	102(4")	8	M4	

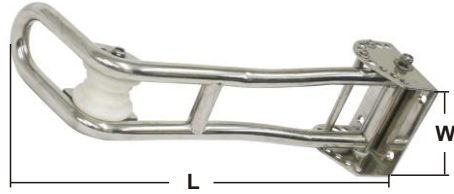

ANCHOR HOLDER AISI 316

Adjustable max 15kg

ITEM NO.	L mm	W mm	Weight
073507	540	150	3.0kg



FENDER HOLDER AISI 304

ITEM NO.		Weight
007938	Φ135mm for 125mm(5") double fenders	625g
007939	Φ160mm for 150mm(6") double fenders	730g
007940	Φ230mm for 200mm(8") double fenders	960g

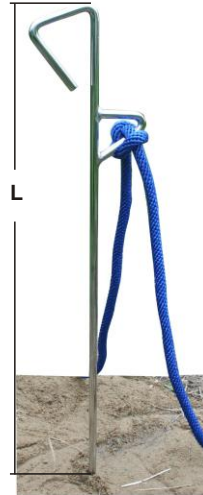

SAND SPIKES

An alternative to more expensive beach and land anchoring devices, this rod securely holds watercraft up to 26 feet (8 meter). Simply push into the ground, or use a hammer in firmer soils, and attach an anchor line to the attachment loop.

ITEM NO.	L cm	Material
020321	86	Steel chrome
020322	86	AISI 304



FLAG POLE 45° AISI 316

Staffs come completely with stainless steel the pole of sockets is 60cm(23-1/2")

ITEM NO.	Base	Weight
009815	98mm x 28mm	422g



FLAG POLE 10° AISI 316

staffs come complete with stainless steel socket, the pole is 43cm(17").

ITEM NO.	Base	Weight
009636	98mm x 28mm	280g

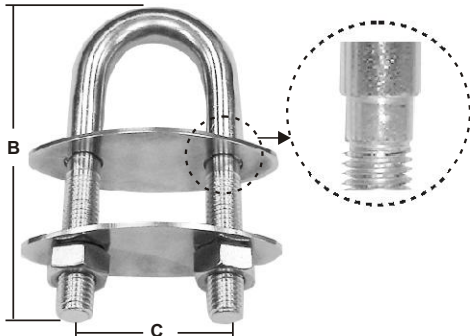

U BOLTS AISI 316

With oval plate

ITEM NO.	Thread	B mm	C mm	Weight/g
005747	M12	120	47	340

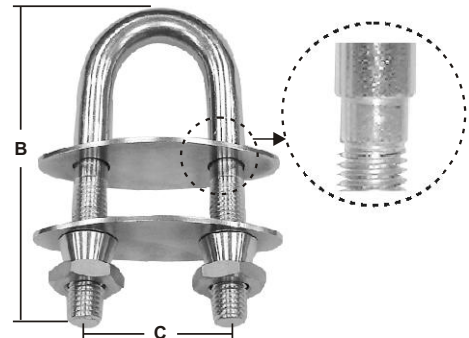

SECURITY U BOLTS AISI 316

With oval plate

ITEM NO.	Thread	B mm	C mm	Weight/g
005750	M12	120	47	350

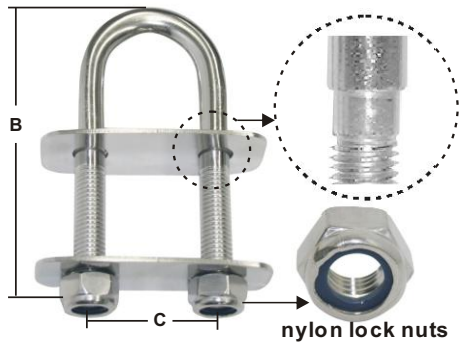

U BOLTS WITH NYLON LOCK NUTS AISI 316

ITEM NO.	Thread	B mm	C mm	Weight/g
005757	M12	120	47	360



FAIRLEADS AISI 316

With oval plate

ITEM NO.	Thread	B mm	C mm	Fixing mm	Weight/g
005733	M6	80	35	6	81

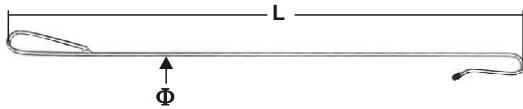

BUOY AND LOCK HOOK AISI 304

ITEM NO.	Φmm	L cm	Weight/g
020319	10	95	



STRONG BUOY HOOK AISI 304

A very strong hook keeps your boat safe on the mooring buoy, easy to pick and release the buoy.

ITEM NO.	Length	Weight/g
020320	120cm	



HOLDER FOR RESCUE DEVICE AISI 304

fit Φ25mm tube rail

ITEM NO.	Size	Weight/g
007936	105mmx65mm	420



HOLDER FOR RESCUE DEVICE AISI 304

fit Φ25mm tube rail

ITEM NO.	Size	Weight/g
007941	Φ95mmx300mm	440

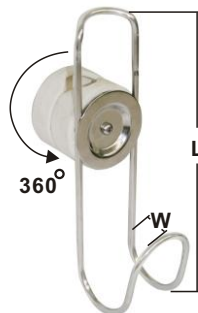

HOOK AISI 304

fit Φ25mm tube rail

ITEM NO.	L mm	W mm	Weight/g
003017	200	50	220



DECK FILL WITH KEY casted AISI 316

ITEM NO.	O.D. mm	Dia mm	Marking	Weight/g
008893	90	50(2")	GAS	710
008894	90	50(2")	DIESEL	710
008895	90	50(2")	FUEL	710

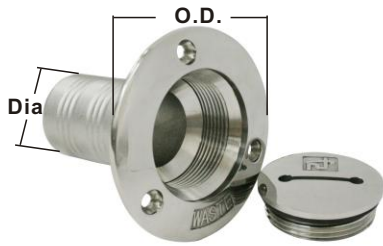

DECK FILLER (WASTE) casted AISI 316

According ISO 8099

ITEM NO.	Dia mm	O.D. mm	Weight
008858	38(1-1/2")	85(3-5/16")	470g



WASTE according ISO8099:200 AISI 316

ITEM NO.	Weight
B16-002	760g



DECK FILLER casted AISI 316

fit for winch handle to close & open.

ITEM NO.	Dia mm	Type	Weight
008887	50(2")	FUEL	680g
008888	50(2")	WATER	680g
008889	50(2")	WASTE	680g
004502	key for deck filler		

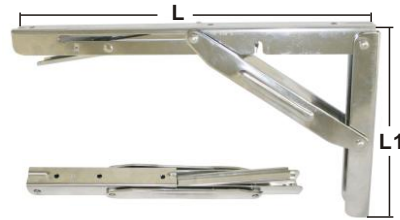

FOLDING BRACKET stamped AISI 304

For tales and working plates, Load up to 150kg

ITEM NO.	L	L1	Weight/g
006133	303mm(12")	165mm(6-1/2")	530

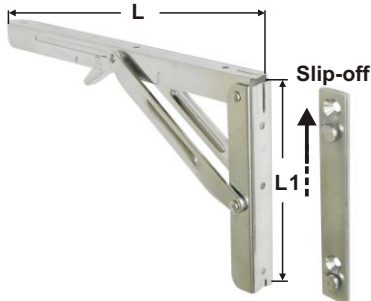

SLIP-OFF FOLDABLE ARMS stamped AISI 304

For table can be slipped off their wall support.

Load up to 150kg

ITEM NO.	L	L1	Weight/g
006135	303mm(12")	165mm(6-1/2")	650

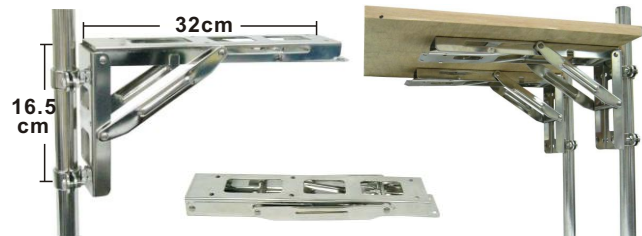

BRACKET ASSEMBLY stainless steel

Folding bracket for table and working plates.

Very stable, load up to 150kg. the set consists of 2 brackets, 4 clips (22-25mm tube) and 4 screw with nuts.

ITEM NO. **006131**



LOW-PROFILE ANTENNA RATCHET MOUNTS WITH HANDLE casted AISI 316

installation on rails of 7/8"(22mm) and 1"(25mm).

ITEM NO.	Thread	Weight/g
009693	1"~14"	600



LOW-PROFILE ANTENNA RATCHET MOUNTS casted AISI 316

no handle installation on rails of 7/8"(22mm) and 1"(25mm).

ITEM NO.	Thread	Weight/g
009692	1"~14"	450

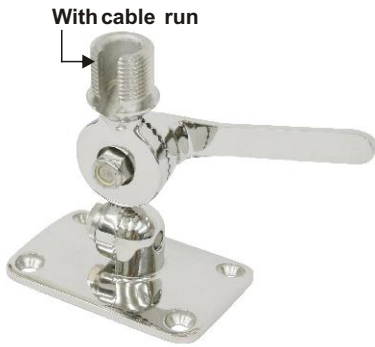

ANTENNA RATCHET MOUNTS casted AISI 316
Socket 4-way ratchet design for mounting versatility.
With cable run.

ITEM NO.	Base	Thread	Weight
009896	2-1/4"x3-1/2"	1"-14	640g economic

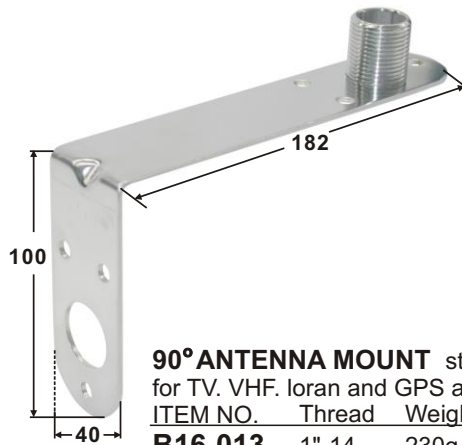

90° ANTENNA MOUNT stamped AISI 304
for TV. VHF. Ioran and GPS antennas

ITEM NO.	Thread	Weight
B16-013	1"-14	230g

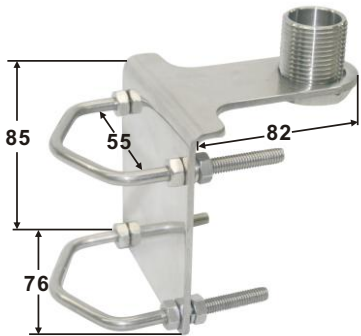

90° ANTENNA MOUNT stamped AISI 304
for TV. VHF. Ioran and GPS antennas

ITEM NO.	Thread	fit Tube Maximum
B16-011	1"-14	Φ55mm



ECONOMY RAIL MOUNT stamped AISI 304
Fit 22mm(7/8") or 25mm(1") rails can also be mounted

ITEM NO.	Thread	Weight/g
009689	1"-14	140



UNIVERSAL MOUNT AISI 316
For GPS/UKW antenne Hinght: 100mm(4")

ITEM NO.	Thread	Weight/g
009871	1"-14	300



LIFT HANDLE LATCH casted AISI 316
Highly-polished

ITEM NO.	Base mm	Weight/g
007109	Φ 44(1-3/4")	110

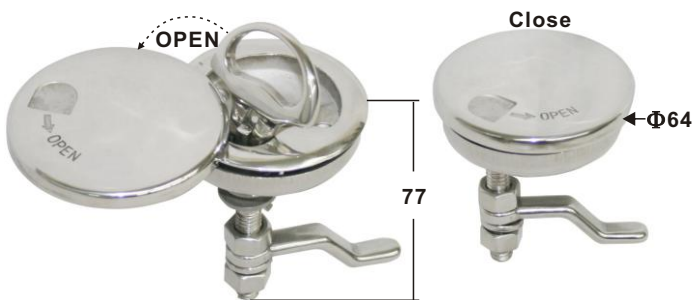

LIFT HANDLE WITH COVER casted AISI 316

ITEM NO.	Weight
007179	350g

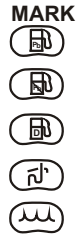

DECK FILLER 45° casted AISI 316

ITEM NO.	Dia mm	Type	Weight
008930	38(1-1/2")	WASTE	470g
008931	38(1-1/2")	GAS	470g
008932	38(1-1/2")	DIESEL	470g
008933	38(1-1/2")	WATER	470g

NEW

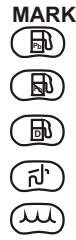

DECK FILL 30° casted AISI 316

ITEM NO.	Dia mm	Type
B19-010	38(1-1/2")	waste
B19-011	38(1-1/2")	gas
B19-012	38(1-1/2")	diesel
B19-013	38(1-1/2")	water

NEW

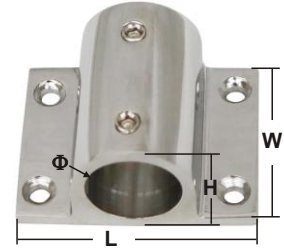

TUBE HOLDER casted AISI 316

ITEM NO.	For tube Φ	L mm	W mm	H mm	Weight
B19-019	22 mm	58	46	29	160g
B19-020	25 mm	61.5	46	33	180g



60° AFT HANDRAIL FITTING casted AISI 316

ITEM NO.	Tube O.D.	Weight
009647	22mm(7/8")	140g

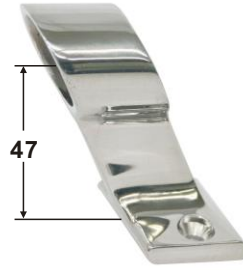

120° FORWARD HANDRAIL FITTING casted AISI 316

ITEM NO.	Tube O.D.	Weight
009648	22mm(7/8")	140g



END STANCHIONS Casted AISI 316
With thread pin

ITEM NO.	Φ	L	H	Weight/g
009646	36	70	86	293

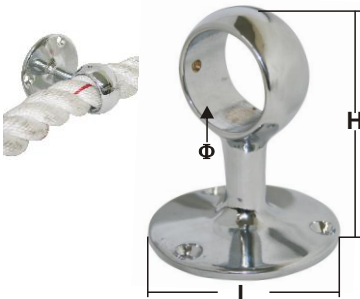

CENTER STANCHIONS Casted AISI 316
Open

ITEM NO.	Φ	L	H	Weight/g
009645	36	70	86	292



90° ELBOW casted AISI 316

ITEM NO.	Tube O.D.	Weight
009686	40mm(1-9/16")	



60° ROUND BASE casted AISI 316

ITEM NO.	Tube O.D.	Weight
009687	40mm(1-9/16")	



60° UNIVERSAL TEE casted AISI 316

ITEM NO.	Tube O.D.	Weight
009684	40mm(1-9/16")	



90° TEE SLEEVE casted AISI 316

ITEM NO.	Tube O.D.	Weight
009694	40mm(1-9/16")	



RAIL FITTING WITH DISTANCE
Attachment 20x17mm AISI 316

ITEM NO.	Φ mm
B18-022	22
B18-023	25

NEW SIZE:32mm SERIES



NEW

90° ROUND BASE casted AISI 316

ITEM NO.	Tube O.D.	Base	Weight/g
009609	32mm(1-1/4")	75mm	260



NEW

60° ROUND BASE casted AISI 316

ITEM NO.	Tube O.D.	Base	Weight/g
009612	32mm(1-1/4")	75mm	260



NEW

60° RECTANGULAR BASE
 casted AISI 316

ITEM NO.	Tube O.D.	Base mm	Weight/g
009617	32mm(1-1/4")	82x42	250



NEW

90° ELBOW casted AISI 316

ITEM NO.	Tube O.D.	Weight/g
009649	32mm(1-1/4")	250



NEW

60° UNIVERSAL TEE
 casted AISI 316

ITEM NO.	Tube O.D.	Weight/g
009669	32mm(1-1/4")	300

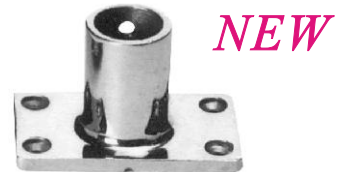

NEW

90° RECTANGULAR BASE
 casted AISI 316

ITEM NO.	Tube O.D.	Base mm	Weight/g
009678	32mm(1-1/4")	82x42	250



NEW

90° TEE casted AISI 316

ITEM NO.	Tube O.D.	Weight/g
009696	32mm(1-1/4")	250



SECURE CLIPS AISI 316
 For turnbuckle, packing 4pcs in one p.p bag

ITEM NO.	Turnbuckle	Weight/g (for 4pcs)
008020	for 5/16"	
008021	for 3/8"	
008022	for 7/16"	
008023	for 1/2"	
008024	for 5/8"	

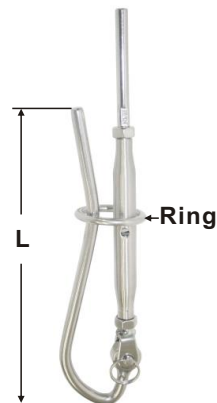

FORESTAY TENSIONER WITH RING AISI 304
 Not include turnbuckle & swadge terminal

ITEM NO.	L mm	Ring ϕ mm (inside)	Wire ϕ mm
004900	115	30	6
004901	105	33	8
004902	220	40	10
004903	260	46	12

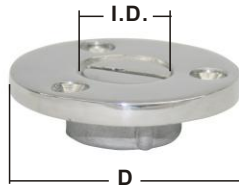

GARBOARD DRAIN PLUG casted AISI 316

ITEM NO.	I.D	D	Weight
003781	17mm	50mm(2")	90g

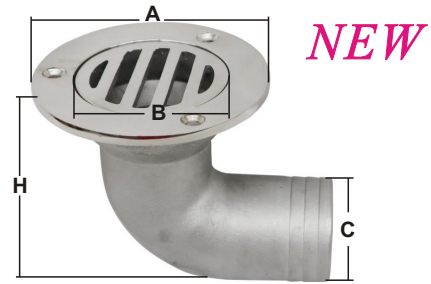

SHOW / COCKPIT DRAINERS stainless steel AISI 316

ITEM NO.	Flange Φ (A)	Application hole (B)	Hose adaptor (C)	H mm	Weight/g
B19-018	80 mm	50 mm	38 mm	70	380



FUEL TANK VENT ROUND HEAD casted AISI 316
 straight

ITEM NO.	Hose size	Weight/g
003777	35mm(1-3/8")	180



FUEL TANK VENT ROUND HEAD casted AISI 316
 straight

ITEM NO.	Hose size	Weight/g
003795	19mm(5/8")	130



PULL DRAIN PLUGS AND SLEEVES AISI 316
 With S.S. chain

ITEM NO.	Size	Weight
009688	25	50g

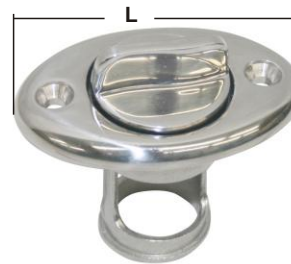

GARBOARD DRAIN PLUG casted AISI 316
 Thread, removeable plug highly polished.

ITEM NO.	Hole mm	L mm	Weight/g
003780	27(1")	64(2-9/16")	110

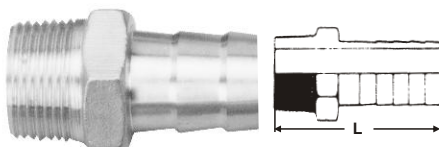

HOSE NIPPLES (HONP)
 Threaded type: DIN 2999, NPT

ITEM NO.	SIZE	L	PACKING	MATERIAL
300034	3/4	72.86	150/Box	AISI 316
300001	1	82.46	80/Box	AISI 316

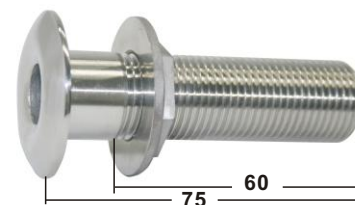

SKIN FITTING casted AISI 316

ITEM NO.	Size	Thread	Weight/g
030012	1/2"	BSP	140
030034	3/4"	BSP	



90 DEGREE THRUHULL MUSHROOM HEAD BARBED casted AISI 316

for use with hose, not for use below the waterline

ITEM NO.	Hose size	Max Thickness	Hull O.D.mm	Flange I.D.mm	Weight/g
010006	19mm	27 mm	43	33	162
010007	25mm	29 mm	43	33	183
010008	38mm	30 mm	59	34.5	393



Y VALVE casted AISI 316
2 way

ITEM NO.	Fit hose	Weight/g
010018	38mm(1-1/2")	1100



SPRING CLAMPS casted AISI 316

for boat hook

ITEM NO.	Min I.D.	Weight/g
003116	1"(25mm)	42



HOOK Casted AISI 316
with rubber cord
Small tools for the practical suspension of ropes

ITEM NO.	Length	Weight/g
003014	72mm	63



MINI LOW FLAT CLEAT with 2 holes AISI 316

ITEM NO.	Length mm	Inch	Weight
003891	80	3-3/16"	39g

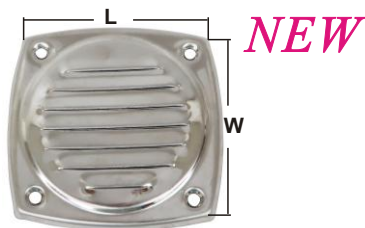

VENT stamped AISI 304

ITEM NO.	L mm	W mm	Thickness	Weight
B19-029	100	100	1 mm	70g



ROUND TRANSOM VENT stamped AISI 304

ITEM NO.	O.D.mm	Weight/g
003743	150(6")	140
003744	150(6") back with S.S. net	150
003750	65(2-9/16")	15
003752	65(2-9/16") back with S.S. net	17



BUTTERFLY VENT stamped AISI 304
 ITEM NO. Φ mm
003740 150(6")



COVER AISI 304
 For ventilation it fit to item no.003727,
 003703,003706(less ventilation)
 ITEM NO. L mm H mm Weight/g
003775 125 125 63



VENT WITH THREAD casted AISI 316
 Heavy duty
 ITEM NO. Lmm x Wmm Thread Weight/g
003797 83 x84 M6 240

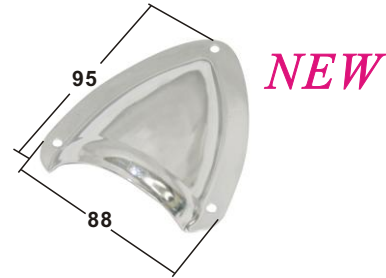

VENT AISI 304
 ITEM NO. LxWxHmm Type Weight/g
003751 95x88x24 midget 50



NiMH accumulator

LOW PROFILE SOLAR VENTS WITH NIMH BATTERY stainless steel cover, stamped AISI 304
 It needs rain or shine whether you're on the boat or not. solar cells power the fans for efficient, active ventilation. Low profile. Single crystal solar cells recharge NiMH battery for 24 hours operation.

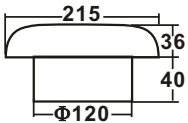

ITEM NO. Basement Weight/g
003794 215mm(8-1/2") 800



DECK THROUGH AISI 304
 Save and dry way to lead the electronic through the deck. Hole dimension Φ 25mm
 ITEM NO. Weight/g
003742 520



UNIVERSAL STRAP
 Stainless steel buckle, polyester webbing
 25mm wide Length:200cm
 ITEM NO. Weight/g
003566 70



FISHING ROD HOLDER casted AISI 316
Adjustable from 22mm(7/8") up to 30mm
(1-3/16") round rails.

ITEM NO.	Length	I.D.	Weight/g
009644	250mm(10")	50mm(2")	1305

Adjustable 22~30mm



CLAMP ON ROD HOLDER casted AISI 316
Adjustable for 7/8" or 1" round rails
mountable on vertical or horizontal rails.
with plastic knob screw.

ITEM NO.	Length	I.D.	Weight/g
009667	9"	1-1/2"	560



CLAMP ON ROD HOLDER casted AISI 316
Adjustable up to 32mm round rail tube
mountable on vertical or horizontal rails

ITEM NO.	Length	I.D.	O.D.
	mm	mm	mm
009666	245(9-5/8")	40(1-1/2")	65(2-1/2")

Can fit rail tube Φ 25mm up to Φ 32mm



CLAMP ON ROD HOLDER casted AISI 316
Adjustable up to 32mm round rail tube
mountable on vertical or horizontal rails

ITEM NO.	Length	I.D.	Weight/g
009697	9"	42mm	610

Can fit up to rail tube Φ 32mm



Fit fishing reel

NO.009576



NO.009570

SMART ROD HOLDER SYSTEM AISI 304

You can set up the rod holder according your demand any Qty any angle.

Rod holder I.D.:40mm. Can fit fishing reel.

Patent pending.

ITEM NO.	Description	L mm	Weight/g
009570	rod holder mounting	175	630
009576	rod holder triple + mounting	920	2130



ROD HOLDER HANGER SET casted AISI 316

ITEM NO.	Weight
009665	320g

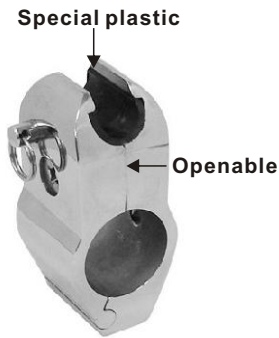

OPENABLE JAW SLIDE casted AISI 316
special plastic inserts ensure smooth movement
& tight rattle free fit. Include pin. Base for top
cap with ball end.

ITEM NO.	Tube O.D.	Weight/g
009690	25mm(1")	260



FLAT BASE casted AISI 316
special plastic inserts ensure smooth
movement & tight rattle free fit.
Include pin & lanyards. Base for top
cap with ball end.

ITEM NO.	Base mm	Weight/g
009691	93x40	161

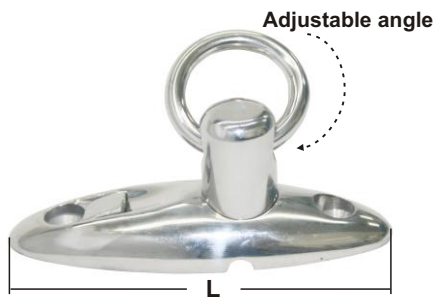

QUICK RELEASE BIMINI casted AISI 316
Adjustable angle

ITEM NO.	L mm	Weight/g
009631	90	150

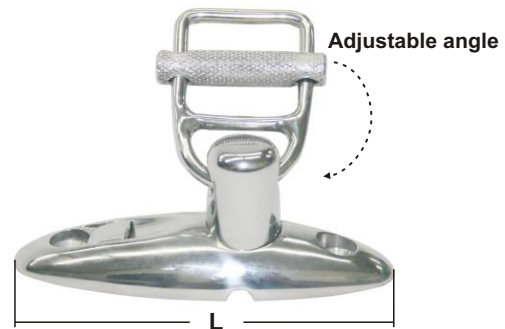

QUICK RELEASE FOR WEBBING casted AISI 316
Adjustable angle

ITEM NO.	L mm	W mm	Weight/g
009634	90	25(1")	180
009639	90	30(1-1/6")	180



**QUICK RELEASE UNIVERSAL
DECK HINGE** casted AISI 316
Adjustable angle

ITEM NO.	L mm	Weight/g
009629	90	165

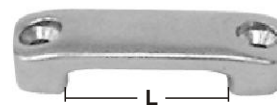

FOOTMAN LOOPS FOR STRAPS
Casted AISI 316

ITEM NO.	L mm	Weight/g
008428	28.5	31
008429	30	31
008431	40	40

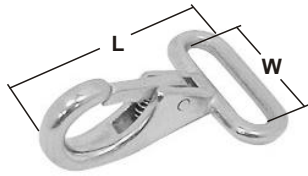

CARBINE HOOK AISI 316

ITEM NO.	L mm	W mm	Weight/g
000407	50(2")	25(1")	25



SNAP HOOK WITH BUCKLE AISI 316

ITEM NO.	L mm	W mm	Weight/g
000409	70(2-3/4")	25(1")	43

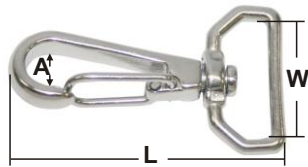

WEB SWIVEL SNAP HOOK Casted AISI 316

ITEM NO.	Amm	Lmm	Wmm	Weight/g
000411	9	65	28	30

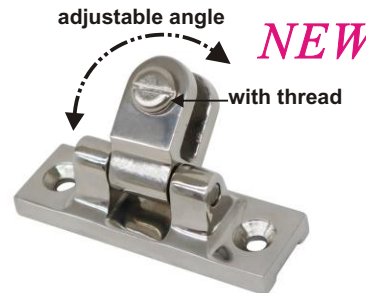

UNIVERSAL DECK HINGE casted AISI 316

ITEM NO.	Base	Weight/g
B19-009	62x21mm(2-5/8"x1-1/8")	100

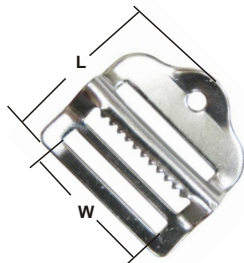

BUCKLE AISI 316

ITEM NO.	L mm	W mm	Weight/g
004323	34(1-5/16")	25(1")	10

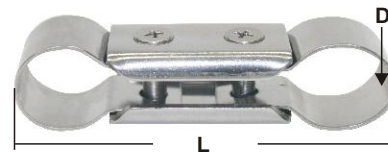

GRAB HANDLE CONNECTION
 stamped AISI 316

ITEM NO.	L mm	D mm	Weight/g
009656	90(3-1/2")	22(7/8")	
009664	90(3-1/2")	25(1")	



TOP CAP DECK FITTING FOR WINCH
 casted AISI 316
 ITEM NO. **B18-002**



FIXING PLATE WITH QUICK RELEASE casted AISI 316
 Disingadge turning the central part.

ITEM NO.	Base mm	Tube O.D.	Weight/g
009640	89x32	22mm(7/8")	320
009641	89x32	25mm(1")	250
009642	89x32	30mm(1-3/16")	300

NEW



CHAIN STOPPER casted AISI 316
For chain 1/4"(6mm) to 5/16"(8mm) removable
pawl flips up when not in use

ITEM NO.	Base measure mm	Width/g
000117	2-1/4"(58)x2-1/8"(54)x1-13/16"(47)H	300



ANCHOR LOCK AISI 316
Channel lock secures anchors
against accidental deployment.
Dia 6mm locking pin locks shackle
or chain to 10mm in place.

ITEM NO.	L mm	W mm	H mm
000141	100	35	35



CHAIN CLAW casted AISI 316
ITEM NO. Chain mm Weight/g
002303 6~8 280



STERN ANCHOR ROLLER AISI 304
mounting for Φ 22mm & 25mm rail tube with belt

ITEM NO.	Φ	Length	Width	Weight
003690	34cm	30m	50mm	5.1kg
003691	38cm	50m	50mm	

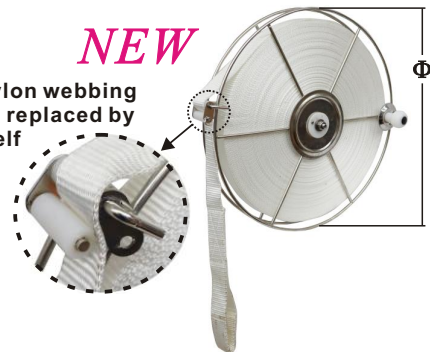

STERN ANCHOR ROLLER AISI 304
mounting for Φ 22mm & 25mm rail tube with belt

ITEM NO.	Φ	Length	Width	Weight
B19-040	34cm	30m	50mm	5.1kg

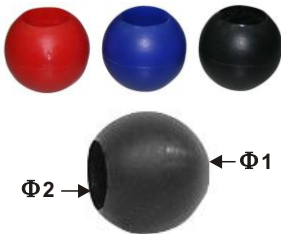

STOPPER KNOBS

Nylon plastic

ITEM NO.	$\Phi 1$ mm	$\Phi 2$ mm	Color	Weight/g
072406-1	6	12.5	red	4
072406-2	6	12.5	blue	4
072406-4	6	12.5	black	4



SINGLE STEP LADDER AISI 316

With non-slip plastic cover and 4 pcs plastic plates which can be adjusted to different degree.

ITEM NO.	Length	Weight
000738	30 cm	580g





NEW

3 STEPS TELESCOP WITH GRAB HANDLES AISI 316

Mounting on the plat form with grab handles for easy entry.

ITEM NO.	Length		Height	Width
	Deployed	stowed		
000739	34" (86cm)	14.5" (37cm)	15" (38cm)	12.5" (32cm)

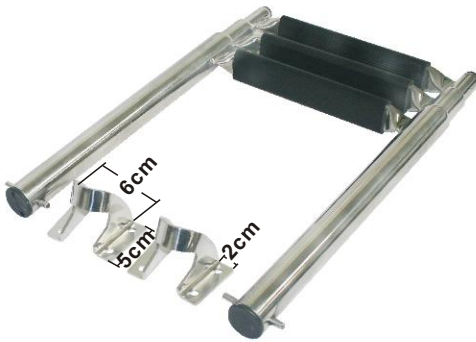

PLAT FORM TELESCOPING 3 DROP LADDER AISI 316

ITEM NO.	Length		Height	Width	Bracket	
	Deployed	stowed			Length	Weight
000736	34" (86cm)	16" (41cm)	16" (41cm)	12.5" (32cm)	5cm	3.5kg



3 STEP TELESCOPE BOW LADDER AISI 316

For a range of Bruce/M-Anchor from 7,5kg up to 20kg
Easy adjustable for any size from 7,5kg up to 20kg.

ITEM NO.	Weight/g
000737	3775

NEW



FOLDING CLEATS casted AISI 316

Folding cleats with recessed screw
do not require a cutout.

ITEM NO.	Length mm	Weight
003876	85(4-3/8")	210g

NEW



FOLDING CLEATS casted AISI 316

Folding cleats with recessed screw do not require a cutout.

ITEM NO.	Length mm	Weight
003892	120(4-3/4")	200g
003889	155(6-1/8")	500g

NEW



FOLDING CLEATS WITH THREAD casted AISI 316

ITEM NO.	Length mm	Thread
B19-004	120(4-3/4")	M10
B19-005	155(6-1/8")	M10

NEW



PULL OUT CLEATS casted AISI 316

ITEM NO.	Length mm	Thread	Weight
B19-006	150(6")	M10	490g
B19-007	200(8")	M10	

NEW



PULL OUT CLEATS casted AISI 316

With stainless steel counter plate and thread

ITEM NO.	Length mm	Thread
B19-015	150(6")	M10
B19-016	200(8")	M10

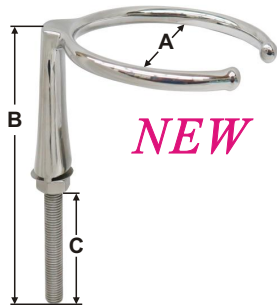

NEW

CUP AND BOTTLE HOLDER AISI 316

ITEM NO.	A mm	B mm	C mm	Model	Width/g
B19-001	88	150	80	single	310

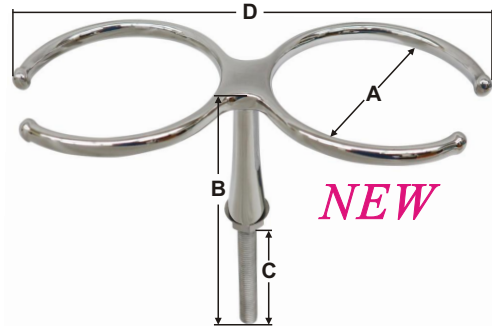

NEW

CUP AND BOTTLE HOLDER AISI 316

ITEM NO.	A mm	B mm	C mm	D mm	Model	Width/g
B19-002	88	150	80	210	double	420



STAINLESS STEEL DRINK HOLDER

Gimbaled caddy holds beverage cans, bottles and glasses level. Includes insulated cozy and clip for flat surface mounting.

ITEM NO.	Box
007798	50

NEW

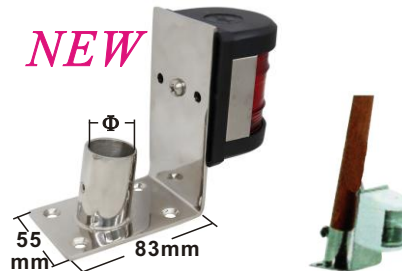

FLAG AND NAVIGATION LIGHT

SOCKETS AISI 304 (Less navigation light)

ITEM NO.	Φmm	Weight
B18-018	25	190g

OPTIMIST COLLECTION

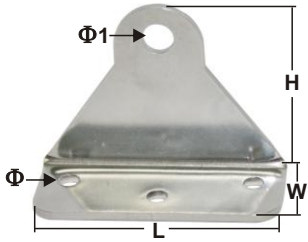

PLATE FITTING FOR RUDDER OPTIMIST

stamped AISI 304

ITEM NO.	L	W	H	Φ	Φ1	Weight/g
	mm	mm	mm	mm	mm	
008741	50	21	38	4.1	6.1	30

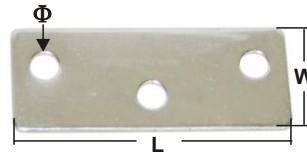
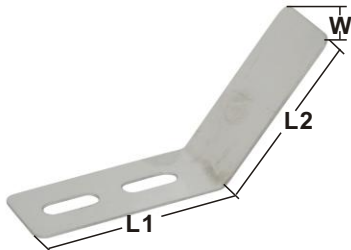

PLATE FOR OPTIMIST stamped AISI 304

ITEM NO.	L	W	Φ	Weight/g
	mm	mm	mm	
008751	50	20	5.5	10



SPRING PLATE FOR OPTIMIST stamped AISI 304

ITEM NO.	L1	L2	W	Weight/g
	mm	mm	mm	
008761	42	38	19	10



FITTING FOR OPTIMIST stamped AISI 304

ITEM NO.	L	W	Φ	Weight/g
	mm	mm	mm	
008762	62	24.5	4.5	10

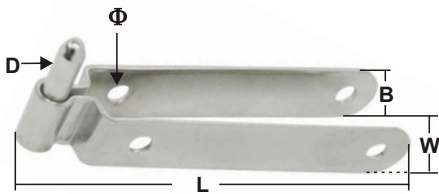

RUDDER FITTING FOR OPTIMIST

stamped AISI 304

ITEM NO.	L	B	D	W	Φ	Weight/g
	mm	mm	mm	mm	mm	
008795	95	15	6	13.1	5.1	40

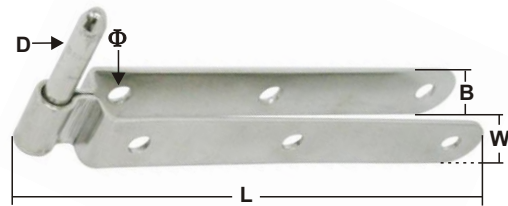

RUDDER FITTING FOR OPTIMIST

stamped AISI 304

ITEM NO.	L	B	D	W	Φ	Weight/g
	mm	mm	mm	mm	mm	
008796	120	15	6	13.1	5.1	50

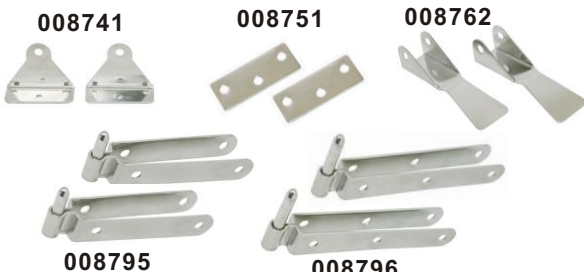

RUDDER FITTING SET

Include 008741x2, 008751x2, 008762x2, 008795x2, 008796x2

ITEM NO.	Weight/g
008700	280



ADJUSTABLE MAST STEP AISI 304

Round type with stainless steel spring which prevents the nut from turning accidentally

ITEM NO.	Weight/g
008702	310

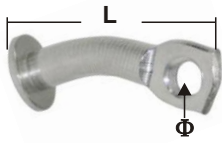

CURVED PIN FOR OPTIMIST

AISI 304

ITEM NO.	L	Φ	Weight/g
	mm	mm	
008704	35	5	10

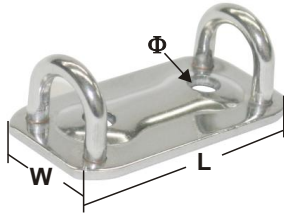

DECK PLATE FOR OPTIMIST

Stamped AISI 304

ITEM NO.	L	W	Φ	Weight/g
	mm	mm	mm	
008705	50	26	5.5	20

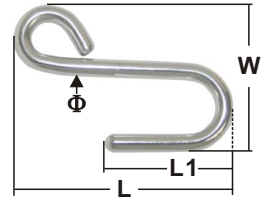

S HOOK AISI 304

ITEM NO.	Φ	L	L1	W	Weight/g
	mm	mm	mm	mm	
004026	5	60	34	38	20



TILLER CLAMP

Stamped AISI 304

ITEM NO.	L	Weight/g
	mm	
008763	78	50



SWIVEL FOR OPTIMIST

AISI 304

ITEM NO.	L	W	Weight/g
	mm	mm	
008764	40	12	20



RAILING LEAD AISI 304

ITEM NO.	L	Weight/g
	mm	
008765	70	45



TRAPEZE RING WITH BAR

AISI 304

ITEM NO.	L	B	Weight/g
	mm	mm	
004634	200	35	72

on request AISI 316



MAST CLIP AISI 304

For optimist boat
stainless steel clip
covered with neoprene

ITEM NO.	Weight/g
008701	50

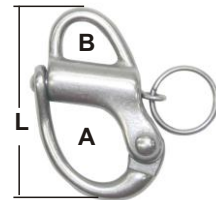

MINI FIXED SNAP AISI 316

ITEM NO.	A	B	L	Weight/g
	mm	mm	mm	
001511	10	7	32	10

NEW



TRIGGER SNAP WITH SWIVEL EYE AISI 316

ITEM NO.	L	L1	D
	mm	mm	mm
B19-034	46	12	14



DOG BONE AISI 304

ITEM NO.	L	Φ	Weight/g
	mm	mm	
B17-008	153	31	45

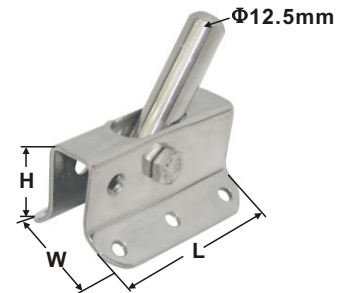

MAST FITTING

Stamped AISI 304

ITEM NO.	L	H	W	Weight/g
	mm	mm	mm	
B17-009	65	35	42	140

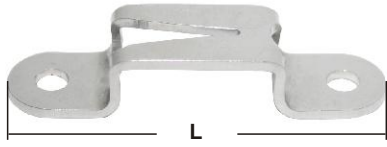

V CLEAT AISI 304
 For school masts and booms

ITEM NO.	L mm
008703	50

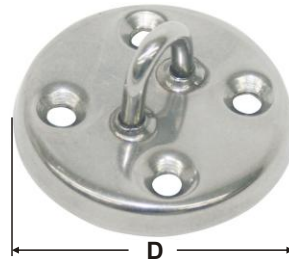

SWIVEL BASE stamped AISI 304

ITEM NO.	Dmm	Weight/g
005061	55	40

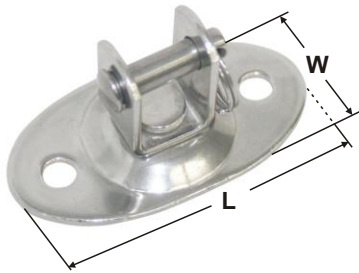

SWIVEL BASE stamped AISI 304

ITEM NO.	L mm	W mm	Weight/g
005063	50	26	

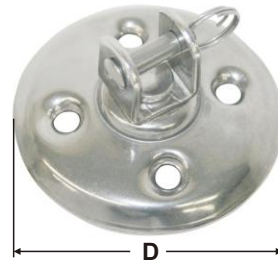

SWIVEL BASE stamped AISI 304

ITEM NO.	D mm	Weight/g
005062	58(2-1/4")	50

ITEM NO.	PAGE	ITEM NO.	PAGE	ITEM NO.	PAGE	ITEM NO.	PAGE
000117	A20	002271	A7	003781	A14	008021	A13
000141	A20	002272	A7	003794	A16	008022	A13
000317	A1	002273	A7	003795	A14	008023	A13
000318	A1	002274	A7	003797	A16	008024	A13
000319	A1	002303	A20	003876	A21	008311	A1
000407	A19	003014	A15	003889	A22	008319	A1
000409	A19	003017	A9	003891	A15	008340	A2
000411	A19	003116	A15	003892	A22	008348	A2
000736	A21	003129	A6	004026	A24	008399	A1
000737	A21	003406	A1	004323	A19	008428	A18
000738	A20	003408	A1	004502	A10	008429	A18
000739	A21	003410	A1	004634	A24	008431	A18
001306-P	A1	003566	A16	004900	A13	008511	A3
001308-P	A1	003590	A5	004901	A13	008512	A2
001310-P	A1	003591	A5	004902	A13	008513	A3
001511	A24	003592	A5	004903	A13	008514	A3
001800	A1	003597	A5	005061	A25	008515	A3
001801	A1	003598	A5	005062	A25	008516	A3
001802	A1	003599	A5	005063	A25	008614	A2
001803	A1	003684	A6	005733	A9	008700	A23
001816	A1	003687	A6	005747	A8	008701	A24
001817	A1	003688	A6	005750	A8	008702	A23
001818	A1	003690	A20	005757	A9	008703	A25
001819	A1	003691	A20	006131	A10	008704	A24
002202	A8	003692	A5	006132	A4	008705	A24
002203	A8	003693	A5	006133	A10	008741	A23
002204	A8	003695	A5	006134	A4	008751	A23
002219	A7	003696	A5	006135	A10	008761	A23
002220	A7	003697	A5	006137	A2	008762	A23
002225	A7	003698	A6	006138	A2	008763	A24
002226	A7	003740	A16	006139	A2	008764	A24
002227	A7	003742	A16	007109	A11	008765	A24
002228	A7	003743	A15	007179	A11	008795	A23
002229	A7	003744	A15	007798	A22	008796	A23
002230	A7	003750	A15	007936	A9	008858	A10
002231	A7	003751	A16	007938	A8	008887	A10
002232	A7	003752	A15	007939	A8	008888	A10
002233	A7	003775	A16	007940	A8	008889	A10
002240	A7	003777	A14	007941	A9	008893	A9
002260	A7	003780	A14	008020	A13	008894	A9

ITEM NO.	PAGE	ITEM NO.	PAGE	ITEM NO.	PAGE	ITEM NO.	PAGE
008895	A9	009694	A12	B19-006	A22	B22-010	N1
008930	A12	009696	A13	B19-007	A22	B22-011	N1
008931	A12	009697	A17	B19-009	A19		
008932	A12	009815	A8	B19-010	A12		
008933	A12	009871	A11	B19-011	A12		
009570	A17	009896	A11	B19-012	A12		
009576	A17	010006	A15	B19-013	A12		
009609	A13	010007	A15	B19-015	A22		
009612	A13	010008	A15	B19-016	A22		
009617	A13	010018	A15	B19-017	A6		
009629	A18	020319	A9	B19-018	A14		
009631	A18	020320	A9	B19-019	A12		
009634	A18	020321	A8	B19-020	A12		
009636	A8	020322	A8	B19-021	A6		
009639	A18	030012	A14	B19-022	A6		
009640	A19	030034	A14	B19-024	A5		
009641	A19	072406-1	A20	B19-025	A5		
009642	A19	072406-2	A20	B19-026	A5		
009644	A17	072406-4	A20	B19-027	A3		
009645	A12	073507	A8	B19-028	A3		
009646	A12	2431-SS	N2	B19-029	A15		
009647	A12	300001	A14	B19-030	A4		
009648	A12	300034	A14	B19-033	A6		
009649	A13	B16-002	A10	B19-034	A24		
009656	A19	B16-006	A7	B19-035	A6		
009664	A19	B16-011	A11	B19-039	A5		
009665	A17	B16-013	A11	B19-040	A20		
009666	A17	B17-008	A24	B19-041	A4		
009667	A17	B17-009	A24	B19-042	A4		
009669	A13	B18-002	A19	B19-043	A4		
009678	A13	B18-013	A5	B19-044	A4		
009684	A12	B18-015L	A3	B19-045	A6		
009686	A12	B18-015R	A3	B19-046	A6		
009687	A12	B18-018	A22	B22-001	N2		
009688	A14	B18-022	A12	B22-004	N2		
009689	A11	B18-023	A12	B22-005	N1		
009690	A18	B19-001	A22	B22-006	N1		
009691	A18	B19-002	A22	B22-007	N1		
009692	A10	B19-004	A22	B22-008	N1		
009693	A10	B19-005	A22	B22-009	N1		

ITEM NO.	PAGE	ITEM NO.	PAGE
003871	P1	B23-041	P5
003874	P1	B23-045	P5
008893	P1	B23-048	P1
008894	P1	B23-049	P1
008895	P1	B23-050	P1
2431-SS	P3	B23-051	P1
B22-001	P3	B23-052	P1
B22-004	P3	B23-053	P2
B22-019	P4	B23-054	P2
B23-002	P3	B23-055	P4
B23-003	P3		
B23-004	P3		
B23-005	P3		
B23-006	P3		
B23-007	P4		
B23-008	P4		
B23-009	P2		
B23-010	P6		
B23-011	P6		
B23-012	P5		
B23-013	P5		
B23-014	P5		
B23-020	P6		
B23-021	P6		
B23-022	P6		
B23-023	P6		
B23-024	P6		
B23-025	P2		
B23-026	P2		
B23-027	P4		
B23-029	P2		
B23-030	P2		
B23-031	P2		
B23-032	P4		
B23-034	P5		
B23-035	P3		
B23-036	P1		
B23-037	P1		
B23-038	P1		
B23-039	P1		